



# The K600i Variable Data Printer

It's just so versatile



Simple, productive and cost effective printer  
for digital variable data printing onto a  
wide range of substrates



<http://bit.ly/2eLzBHs>  
Scan the code to find more  
about the Domino K600i.

Domino. Do more.

## K600i - it's just so versatile

Printing on to a wide range of substrates, the **K600i** combines productivity with 600dpi print quality.

The **K600i**, configured to the print width required, can be integrated into an existing web or sheet handling system for digital imprinting or can be in the format of a monochrome digital press.

This added-value offering to your customers will increase your sales and profitability.

Available with high impact UV-curable inks as well as cost effective aqueous pigmented inks.

With more than 500 installations **K600i** is a world leader.

## A diverse range of applications

Designed for sheet or web – printing onto labels, tags, tickets, forms, security products and direct mail.



Personalisation of high quality pre-printed labels including variable 2D codes such as QR codes.



For tickets and forms, printing 2D codes, barcodes and numbering sequences.



For overprinting fully personalised variable and secure data, ideally suited for security fiscal stamps, event tickets, game, phone cards and pharmaceutical folded carton packaging.



### Greener credentials

Domino's commitment and investment in sound environmental practices means we frequently exceed the increasingly demanding governmental, industry and company standards and regulations. We are committed to minimising the consumption of natural resources and energy and the creation of waste. Our products are RoHS and WEEE compliant so that they are recyclable.

#### K600i

The **K600i** is supplied with UV curable, LED curable and aqueous inks representing an efficient use of our natural resources. Although UV curable inks are chemicals and need to be used correctly, they offer significant environmental benefits compared to solvent alternatives. Solvent inks include up to 95% volatile solvents that evaporate into the environment and require regular print head cleaning. **K600i** UV curable inks contain 1% volatile solvents.

## The K600i Product Range

Each printer includes a compact print bar with mounting bracket and integrated Domino **i-Tech CleanCap** maintenance station.

### K600i Variable Data Printing

High quality digital variable data printing at speeds up to 200m/min (650ft/min) @ 600 dpi.

### K600i Digital Cold Foiling

Innovative digital solution enabling conventional metallic foils to be digitally applied to labels, packaging and security products.

### K600i Varnish

Spot and tactile varnish capability without the need for printing plates or screens.

### K600i White

The renowned cost-effective alternative to screen printing, ideal for a wide range of labels and packaging applications.

See separate K600i Embellishment printer brochure for details of K600i Digital Cold Foiling, K600i Varnish and K600i White.

## Simple

Compared with other digital printing technologies, Piezo ink jet is a non-contact form of printing with few moving parts. There are fewer requirements for manual intervention. The result is enhanced reliability.

## Modular

Print widths range from a single print module, covering 108mm (4.25") up to seven dual print modules with a print width of 782mm (30.81"). Print head alignment and image stitching is achieved through the Domino **i-Tech StitchLink** micro-motor controller technology. It is easy and accurate for rapid set up of high quality images.

Print Modules	Print width	
	(mm)	(inches)
x 1	108	4.25
x 2 or 4	220	8.69
x 3 or 6	333	13.11
x 4 or 8	445	17.54
x 5 or 10	558	21.96
x 6 or 12	670	26.39
x 7 or 14	782	30.81

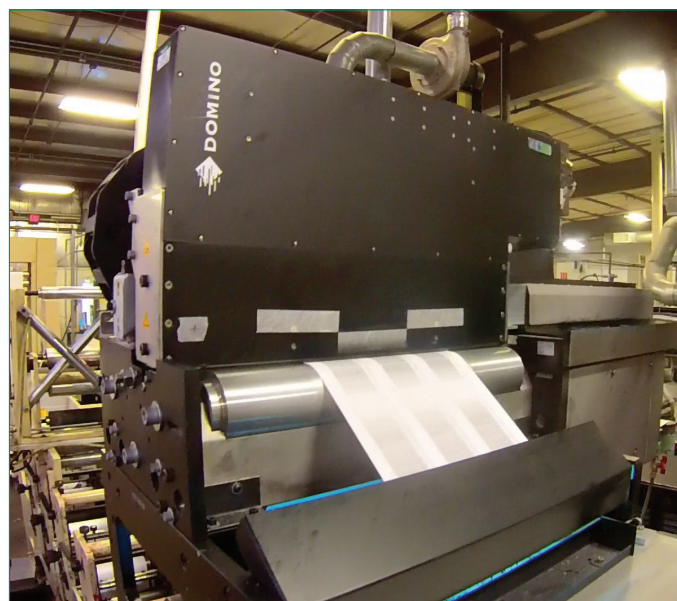

## Printing speeds:

- At 600 x 600 dpi – 75m/min (246ft/min) with optimum density
- At 600 x 600 dpi – 100m/min (328ft/min)
- At 600 x 300 dpi – 150m/min (492ft/min)

## Dual Bar:

- At 600 x 600dpi – 150m/min (492ft/min) with optimum density
- At 600 x 600dpi – up to 200m/min (650ft/min)

**Domino. Do more.**

## intelligent Technology

Domino's **i-Tech** components combine to create a system with superior performance, altogether more flexible and reliable.



### **i-Tech ActiFlow**

Ink re-circulation for superior jetting performance and reliability.

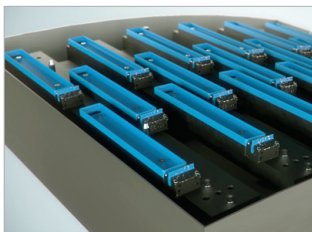

### **i-Tech CleanCap**

Automated print head cleaning and capping station for the optimum print quality and productivity.

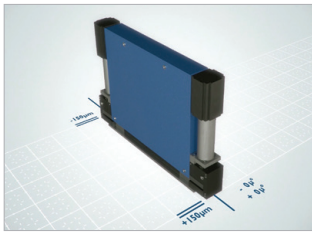

### **i-Tech StitchLink**

Automated print head alignment for accurate registration and seamless print across the full web print width.

## High reliability with minimal maintenance

We want to keep the print heads running. The unique Domino **i-Tech ActiFlow** ink circulation system ensures that the ink is always moving around the printhead, even when it has stopped. This degasses the ink preventing air bubbles forming that can impact nozzle performance. **ActiFlow** maintains consistent and reliable print results and reduces operator intervention.



## Higher uptime and reduced costs of maintenance improves your profitability

The revolutionary **i-Tech CleanCap** automated print head cleaning and capping technology means the **K600i** almost maintains itself. **CleanCap** is a clean and consistent controlled process. This means there is no time consuming daily manual print head cleaning with the risk of print head nozzle blockage or print head damage being dramatically reduced.

When not in operation the print head is automatically moved into the **CleanCap** where the head is wiped and capped ready for the next use.

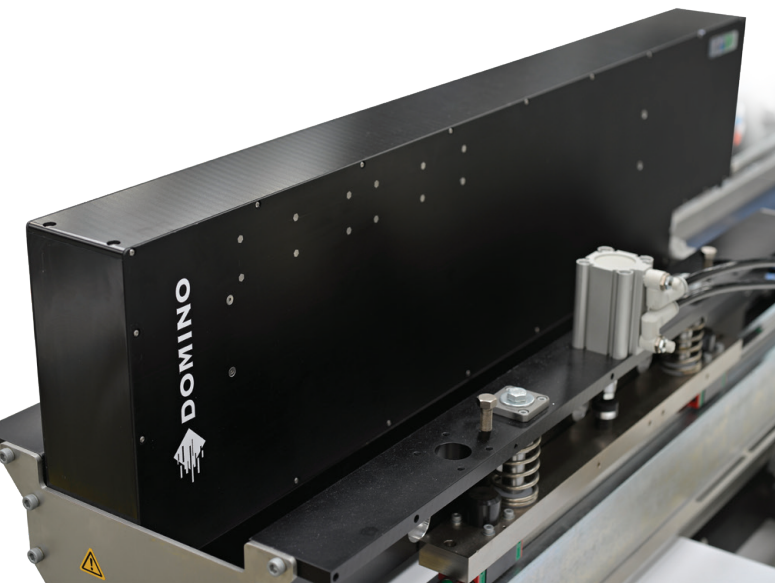

## Easy to Integrate

The compact design facilitates mounting on a press, finishing line, mail base or sheet-fed base...we just need some space and good material control to convert you to digital.

Equipment options include a roller section and web extension, enabling simple integration into your existing machine.

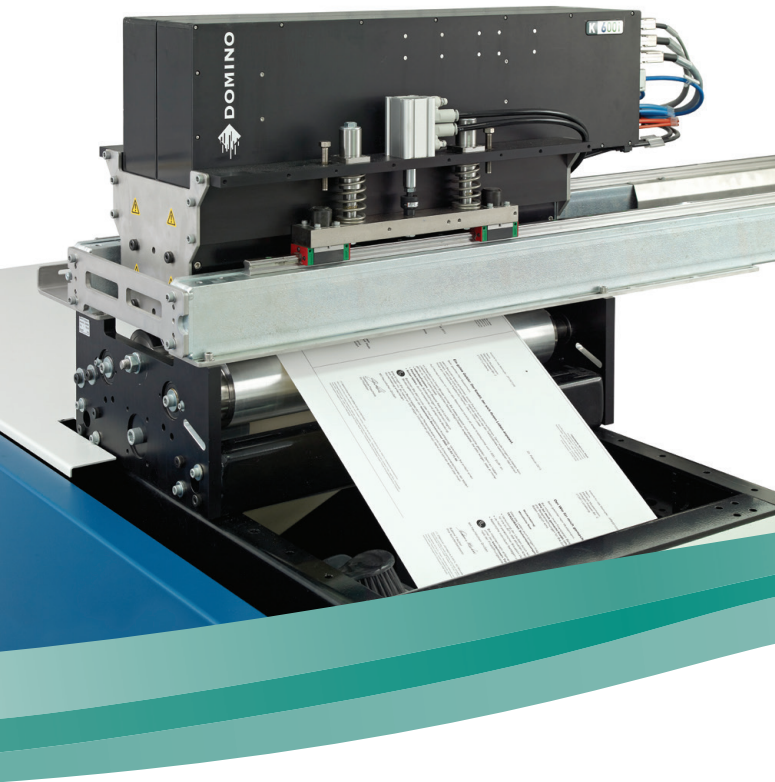

## Pay for what you use

The **K600i** has few consumable parts. The ink and flush are charged based on the amount used.

Select one of four drop sizes (6, 7, 11, 14pl) for each job. Optimise print quality for a given media or reduce production costs by controlling ink usage. For the highest quality requirements, use with the Domino **Editor™ RIP** including greyscale capability, where multiple different drop sizes are used to create the images.



## Specialist inks

A range of inks are available including a fluorescent UV-readable ink for brand protection and security printing.

## Why use digital monochrome printing?

- ✓ **Unparalleled productivity** - operating at speeds of up to 200m/min (650 ft/min)
- ✓ **High print quality** - with a native resolution of 600dpi and potential for greyscale printing
- ✓ **Versatile** - compact, modular, configurable to the print width required from 108mm (4.25") to 782mm (30.81")
- ✓ **Reliable** - simple non-contact printing with few moving parts minimises manual intervention and reduces downtime
- ✓ **Low cost investment** - compared to the purchase of a digital press, makes use of your existing production equipment to provide added value variable data printing
- ✓ **Low operating costs** - select one of our drop sizes (6, 7, 11, 14pl) to optimise print quality on different substrates, or control ink usage and reduce your cost per job
- ✓ **Reduced setup time** - **i-Tech StitchLink's** unique automated micro-motor controller technology enable precise head alignment with no stitchline
- ✓ **Reduced downtime** - the **i-Tech ActiFlow** continuous ink circulation system degasses the ink preventing air bubbles and blocked nozzles, resulting in less rejects and less maintenance
- ✓ **Low maintenance** - **i-Tech CleanCap** automated print head cleaning and capping station reduces the risk of print nozzle blockages and extends the life of your print head

**Domino. Do more.**

# Workflow efficiency – It is not just about printing

## Industry Standard Ink Jet & Line Controller

The Domino **Editor™ GT** PC based controller, with over 2000 installations and Domino **Editor® Starlight** are available for receiving and configuring data files for printing. A number of data formats can be received.

In addition data creation tools are available such as cut and stack and step and repeat numbering. To meet your application needs, a range of machine control options are available including Mail Sort and in-line camera verification. Network solutions are available for remote data preparation and set-up.



## Data Hungry

For applications with significant variable data content requiring the highest quality output, or where a PDF workflow is preferred we have the Domino **Editor™ RIP**. This modular solution ranging from simple desk top through to multiple rack mounted blades, can be configured to process your data requirements. Also supports full greyscale image processing for the highest quality printed output. Includes options for PDF files as well as IPDS and AFP data streams.



## Quadient – Inspire Designer

The industry standard Quadient-Inspire Designer software creates multi-page PDF files that can then be printed with the K600i **Editor™ RIP**. Starting with a simple layout tool, data is extracted from a variable data file and then integrated within the template background image creating multi-page PDF files ready for printing.

# A quick tour around the K600i

## *intelligent Technology*

**i-Tech** components combine to create a system altogether more flexible and reliable.

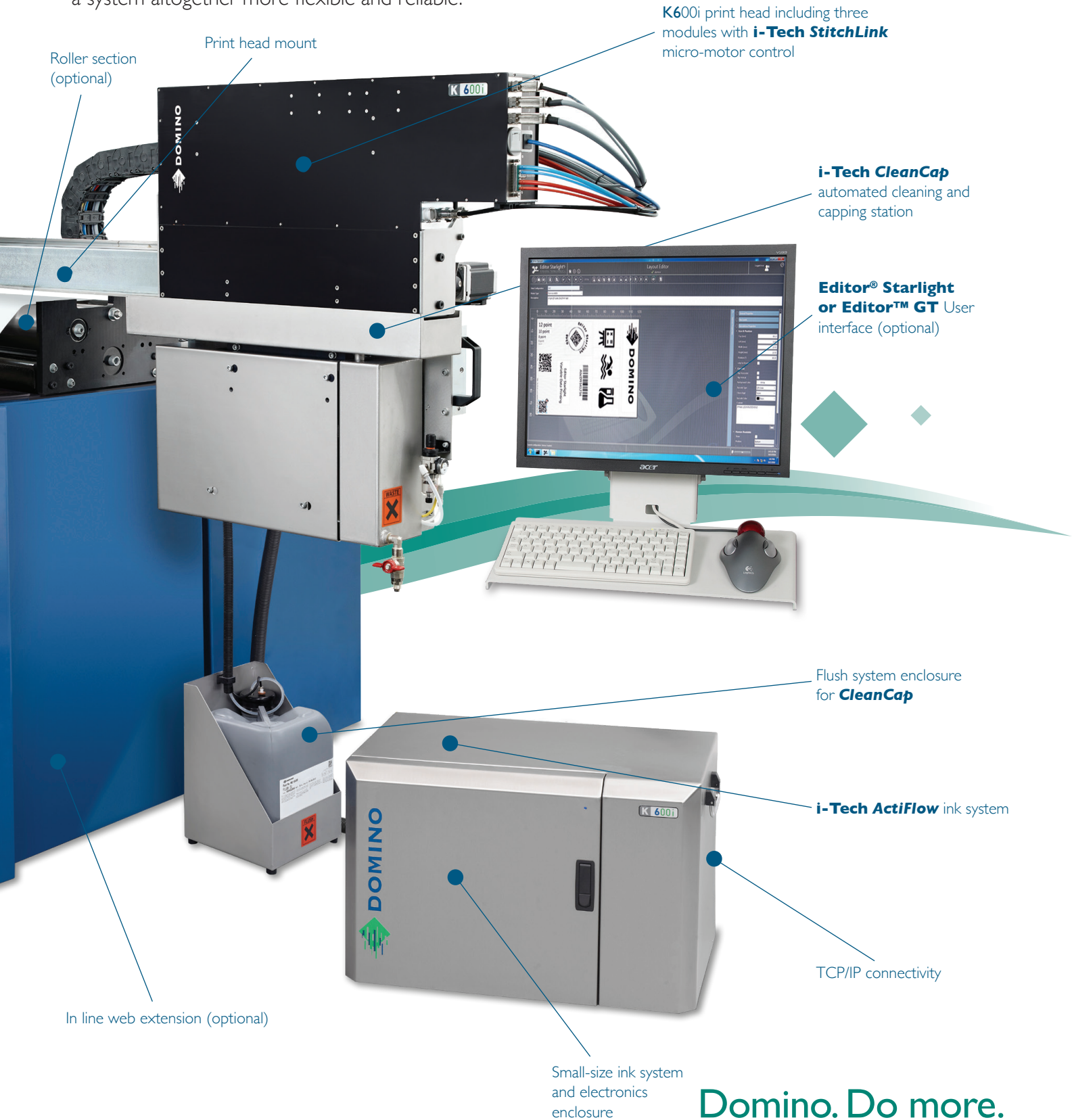

Roller section (optional)

Print head mount

K600i print head including three modules with **i-Tech StitchLink** micro-motor control

**i-Tech CleanCap** automated cleaning and capping station

**Editor® Starlight or Editor™ GT** User interface (optional)

Flush system enclosure for **CleanCap**

**i-Tech ActiFlow** ink system

TCP/IP connectivity

Small-size ink system and electronics enclosure

In line web extension (optional)

## Domino. Do more.

## Technical Specification:

### Operational Capability

Maximum line speed Standard	37.5 – 150 m/min (123 – 492 ft/min)
Maximum line speed Dual	150 – 200 m/min (492 - 650 ft/min)
Print resolution	300dpi - 600dpi - 1200dpi options
Nominal drop sizes	6, 7, 11, 14pl (14pl drop only at reduced speeds)
Image width range	108mm (4.25") to 782mm (30.81")
Nominal media to print head distance	1.0mm (0.04")
Media	Coated and uncoated paper; foil and plastic

### Ink System

Ink Supply	1 - 10 litres (ink dependent)
Ink Type	UV Curable / LED Curable / Aqueous / Foil Adhesive / White Heavily Pigmented

### Workflow

#### Editor™ Starlight/Editor™ GT:

Fonts: Windows® True Type, Adobe, OCR,  
 Barcodes: Australian Post Custom, Australian Post Redirect, Australian Post Reply Paid, Australian Post Routing, CodaBar 2 widths, Code 11, Code 2 of 5 Data Logic, Code 2 of 5 IATA, Code 2 of 5 Industry, Code 2 of 5 Interleaved, Code 2 of 5 Matrix, Code 2 of 5 Standard, Code 39, Code 39 (ASCII), Code 93, Code 93 (ASCII), Code 128, Code 128A, Code 128B, Code 128C, DPD Code, DP Identcode, DP Leitcode, EAN13, EAN13P2, EAN13P5, EAN14, EAN8, EAN8P2, EAN8P5, EAN128, Flattermarken, GSI-128, GSI DataBar, GSI DataBar Expanded, GSI Data Bar Expanded Stacked, GSI DataBar Limited, GSI DataBar Stacked, GSI DataBar Stacked Omnidirectional, GSI Data Bar Truncated, ISBN, Italian Postal, Japanese Postal, KIX, Korean Postal, LOGMARS, MSI, NVE-18, Pharmacode One-track, Pharmacode Two-track, PLANET 12, PLANET 14, Plessey, Plessey Bidirectional, PZIN, Royal Mail 4State, SSCC-18, Telepen, Telepen Alpha, UCC/ EAN 128, UPC 12, UPC 25, UPC A, UPC-A P2, UPC-A P5, UPC-E, UPC-E P2, UPC-E P5, USPS Intelligent Mail Barcode, USPS PostNet5, USPS PosNet6, USPS PostNet9, USPS Post-Net10, USPS PostNet 11, USPS PostNet 12.

2D Codes: Data Matrix, MicroPDF417, PDF417, PDF417 Truncated, QR-Code, Quantum-code

Graphics: .bmp, .pcx, .tif, .jpg, .gif, .pdf

Editor™ RIP: IPDS, AFP data streams & PDF files

### Key Dimensions

Conduit length - main enclosure to print head 4m (13') for 1x1 module, 5m (16') for 1x2 or 1x3 module, otherwise 4.25m (14')	
Conduit length - main enclosure to flush bottle 4m (13')	
1x3 head print bar	1330w x 354.4d x 705.4h mm (height dimension excludes conduit)
Small-size 10L ink supply box	640w x 441d x 425h mm (dimensions exclude conduit radius*)
Mid-size 10L ink supply box	800w x 400d x 1810h mm (dimensions exclude conduit radius*)
Flush holder	234w x 234d x 360h mm (dimensions exclude air regulator and conduit radius*)

\*Width is configurable, please see below

### Services

Electrical	K600i	110-240v AC50-60Hz 10A (auto ranging)
	UV System	Operation dependent, normally 380-420v three phase drop
Compressed Air		6-8 bar clean dry supply

### Environment

Optimum temperature range	20-30°C (68-86°F)
Optimum humidity range	40-60%

### Ancillary Equipment

Print head guarding, UV dryer, LED UV pinning, Web cleaner, Web guide, Anti-static bars, Mail base, Web extension, Reel to reel system, Arched roller section, Corona treatment.

Small enclosure - 10 litre ink supply box for up to 3 print nozzles or 333mm/13" wide print systems

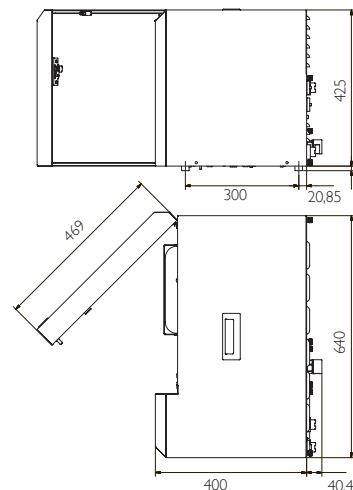

Mid-size ink supply box for all print systems above 3 print modules

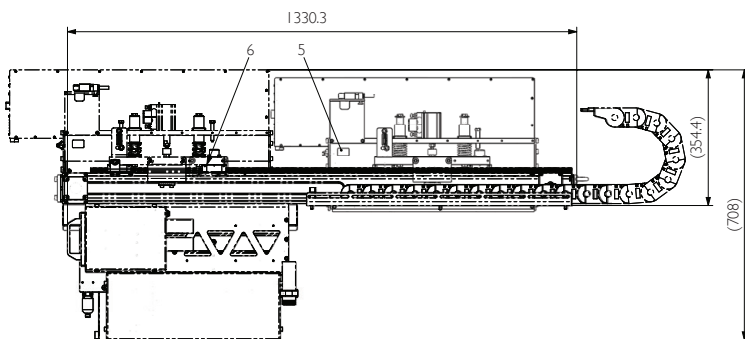
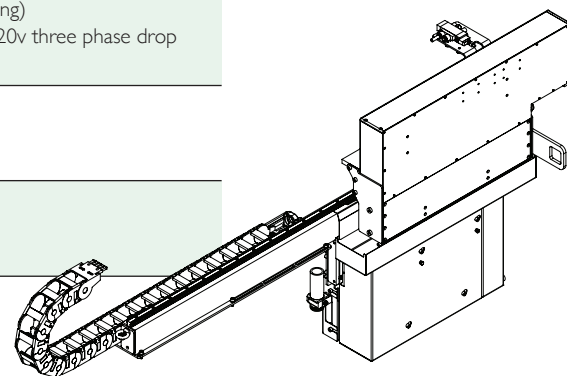
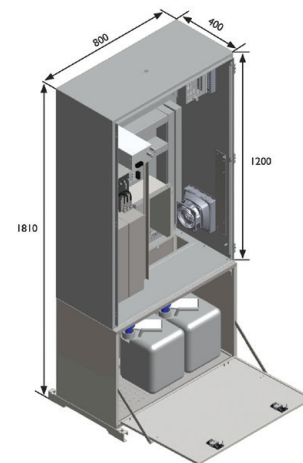

Print width to	Head Mount lengths
108mm (4.25") Single	1339mm*, 1800mm, 2215mm
333mm (13") Single	1339mm*, 1800mm, 2215mm
333mm (13") Dual	1400mm*, 1800mm, 2215mm
558mm (22")	1800mm*, 2215mm, 2600mm
782mm (30")	2400mm*, 2800mm, 3400mm

\*Standard length; bespoke length head mounts upon special request



<http://bit.ly/2eLcpZM>